



DELO
SCELT I PER TE

Serie MAYA

Rubineria bagno

La serie MAYA dispone di una particolare tecnologia per l'ottimizzazione dell'efficienza energetica:

LIMITATORE DI ENERGIA: Apertura dell'erogazione dell'acqua fredda con leva in posizione centrale, evitando l'accensione involontaria della caldaia. Inserito sugli artt. 3008001, 3008002, 3008003, 3008010.

LIMITATORE DI TEMPERATURA: permette di decidere la temperatura massima dell'acqua.

REGOLATORE DINAMICO DI PORTATA: blocca l'alzata della leva al raggiungimento della metà della portata, riducendo il consumo del 50%.

CARTUCCIA D. 35 mm A IMMERSIONE TOTALE: diminuisce l'usura meccanica della cartuccia

LAVABO

Scarico 1"1/4

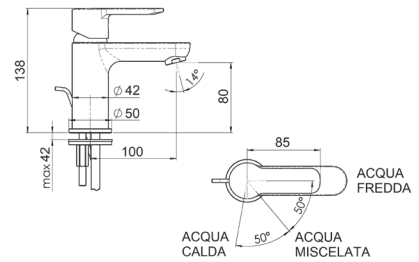
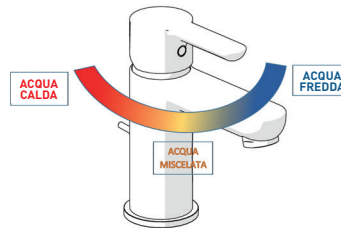

codice	UM	min. ord.	conf.	cat.	€
● 3008001	NR	1	10	11	

LAVABO MANIGLIA STANDARD

Scarico 1"1/4, apertura maniglia classica.

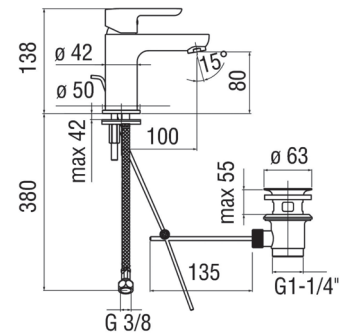

codice	UM	min. ord.	conf.	cat.	€
● 3008011	NR	1	10	11	

LAVABO "BIG SIZE"

Scarico 1"1/4

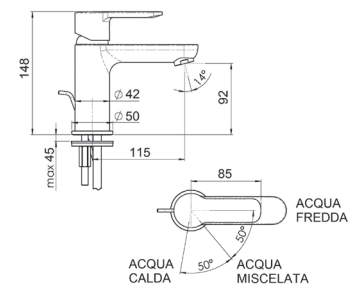
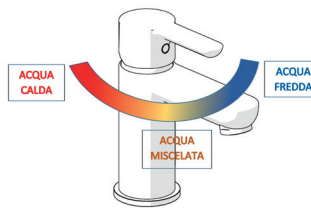

codice	UM	min. ord.	conf.	cat.	€
● 3008010	NR	1	10	11	

LAVABO "BIG SIZE" MANIGLIA STANDARD

Scarico 1"1/4, apertura maniglia classica.

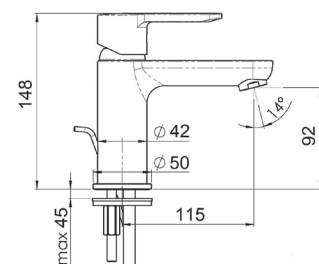

codice	UM	min. ord.	conf.	cat.	€
● 3008009	NR	1	10	11	

RUBINETTERIA BAGNO

Serie MAYA

LAVABO CORPO ALTO

5
l/min

Scarico automatico 1"1/4,
con meccanismo clicker.

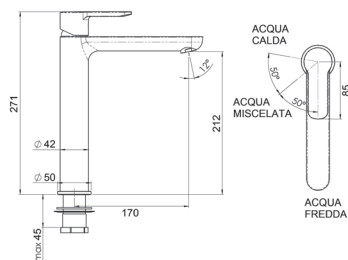
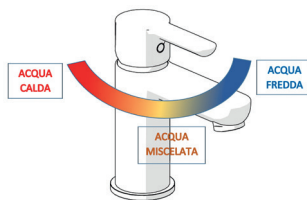

codice	UM	min. ord.	conf.	cat.
● 3008002	NR	1	6	11

BIDET

5
l/min

Scarico 1"1/4

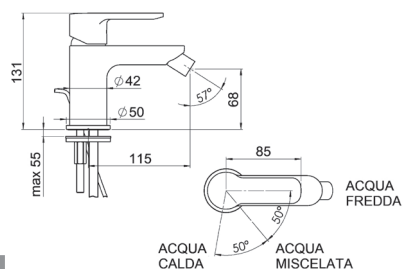
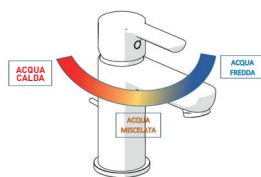

codice	UM	min. ord.	conf.	cat.
● 3008003	NR	1	10	11

BIDET MANIGLIA STANDARD



Scarico 1"1/4, apertura maniglia classica.

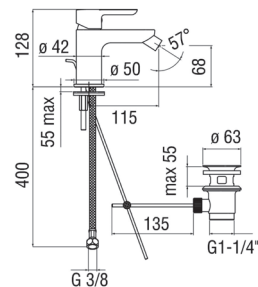

codice	UM	min. ord.	conf.	cat.
● 3008012	NR	1	10	11

DOCCIA INCASSO CON DEVIATORE



Incluso corpo incasso

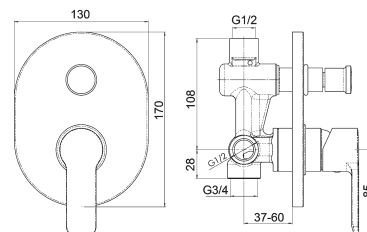

codice	UM	min. ord.	conf.	cat.
● 3008006	NR	1	8	11

DOCCIA INCASSO

Incluso corpo incasso

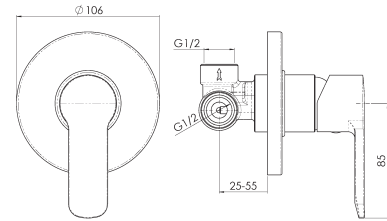

codice	UM	min. ord.	conf.	cat.
● 3008004	NR	1	30	11

DOCCIA ESTERNO

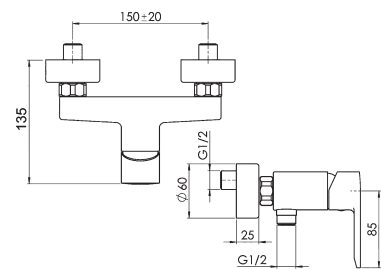

codice	UM	min. ord.	conf.	cat.
● 3008005	NR	1	20	11

VASCA CON KIT DOCCIA

Flessibile cm. 150

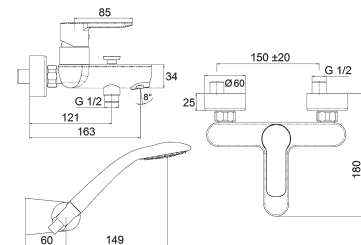

codice	UM	min. ord.	conf.	cat.
● 3008007	NR	1	8	11